

SECTION A-A

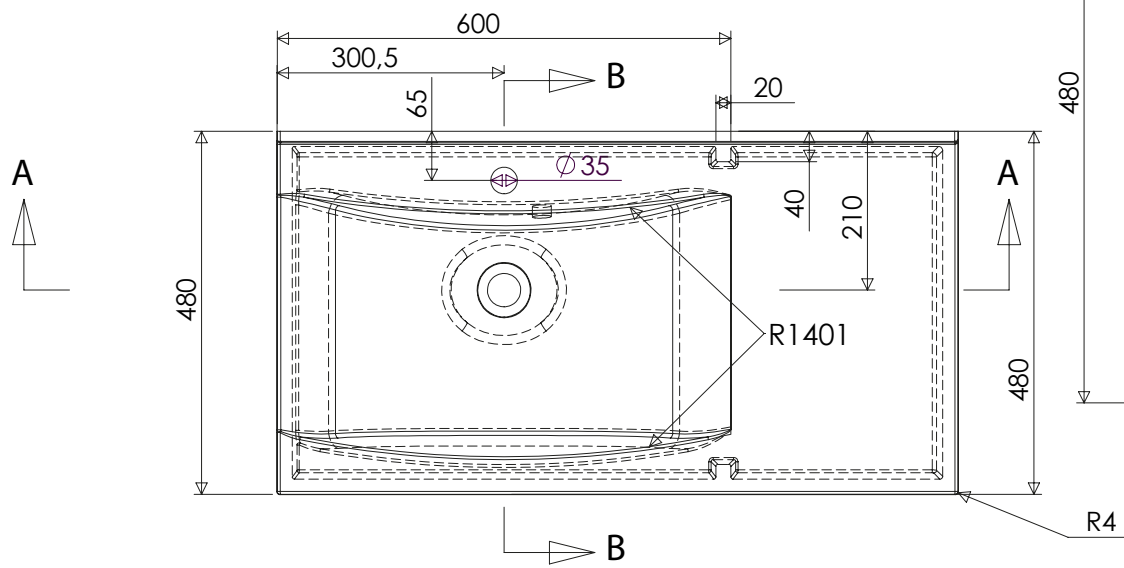

SECTION B-B

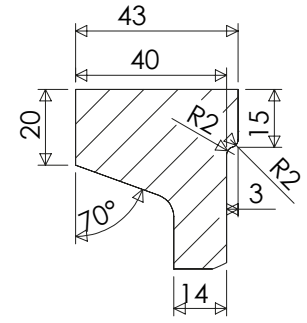
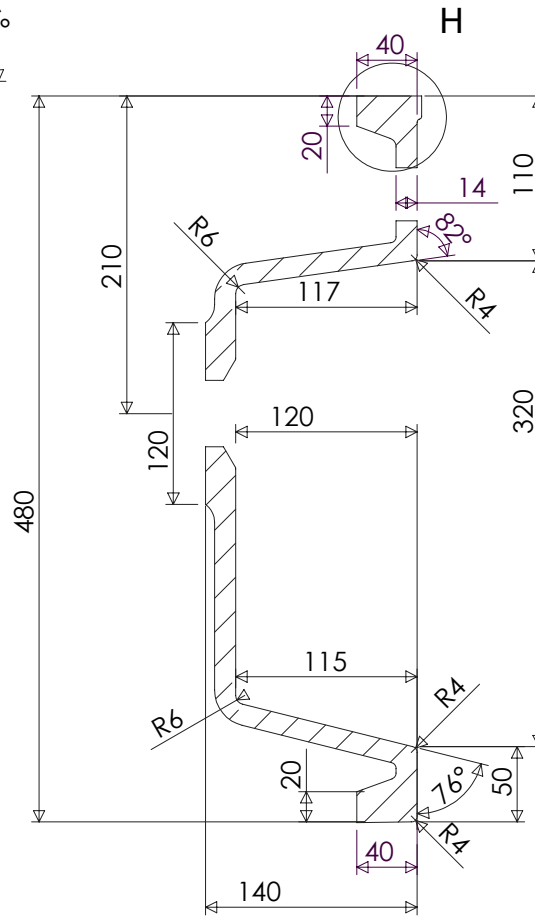

DETAIL H

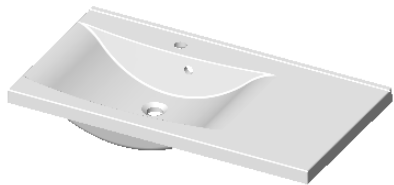

**50093**