













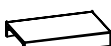

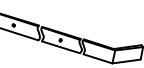

A  Ø6*30 X8	B  X2	C  ST4*30 X6	D  X6	E  ST4*12 X6	F  X2	G  X1	H  X1	
I  X2	J  X2	K  X2	L  X1	M  X2	N  X1	O  X1	P  X1	
Q  X1	R  ST4*30 X2	S  X2	T  X1					



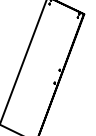

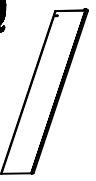
7

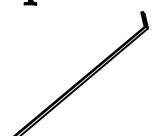
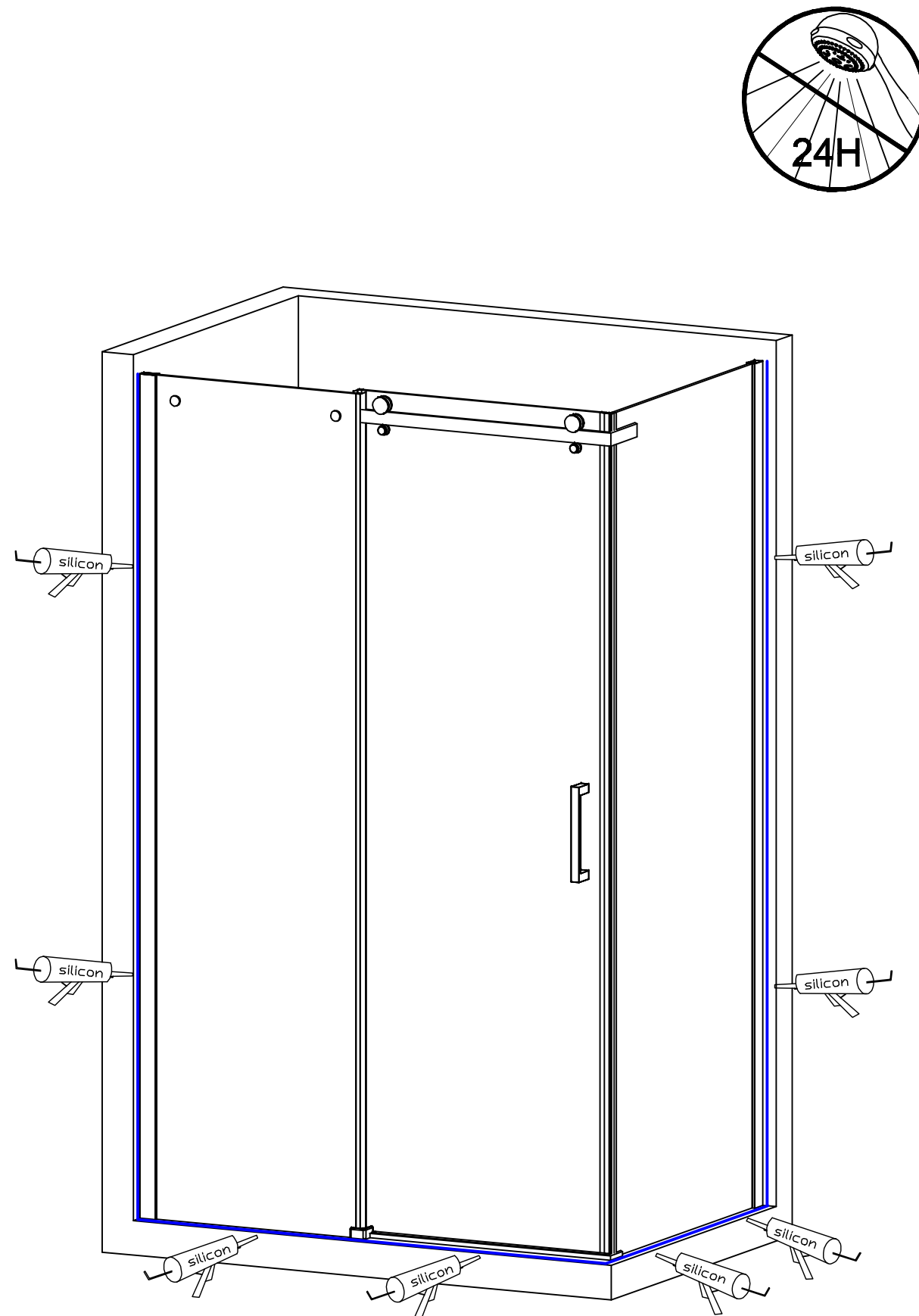
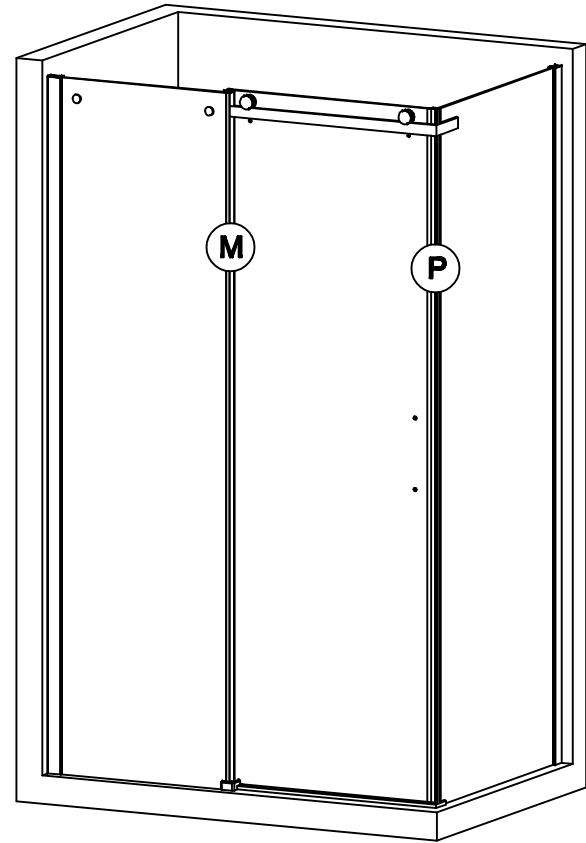
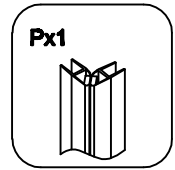
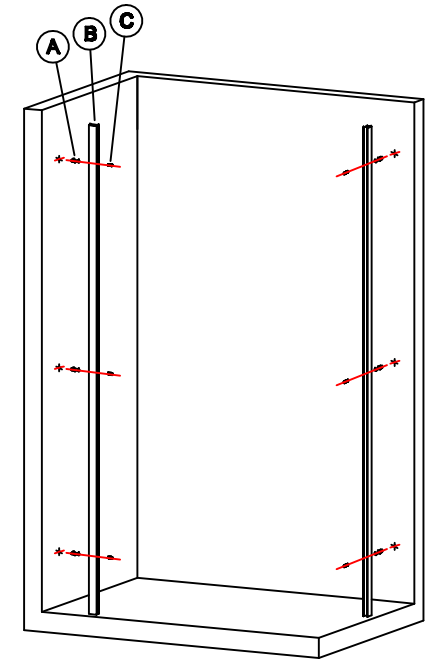
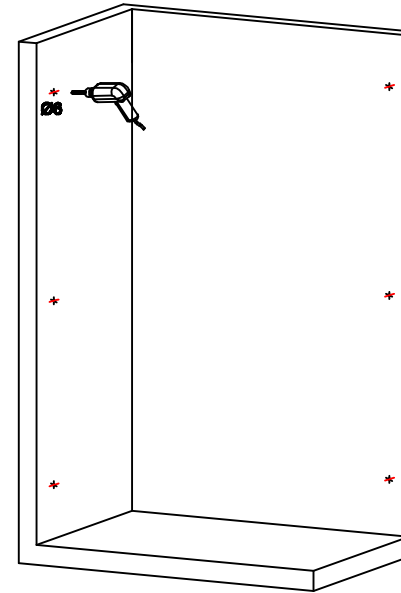
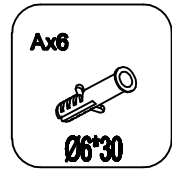

1

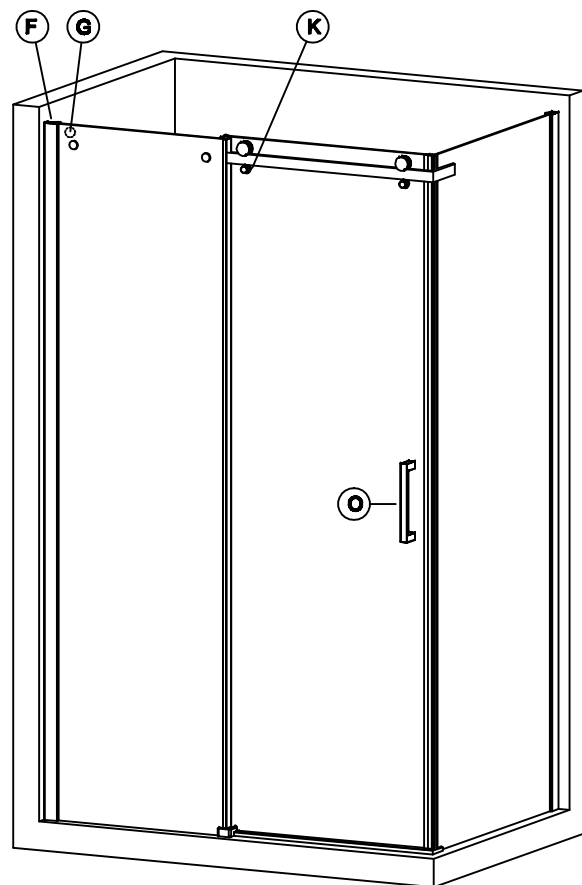
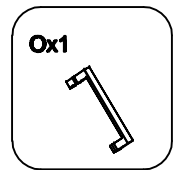
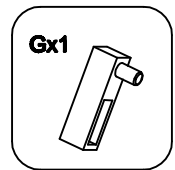
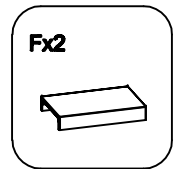

8

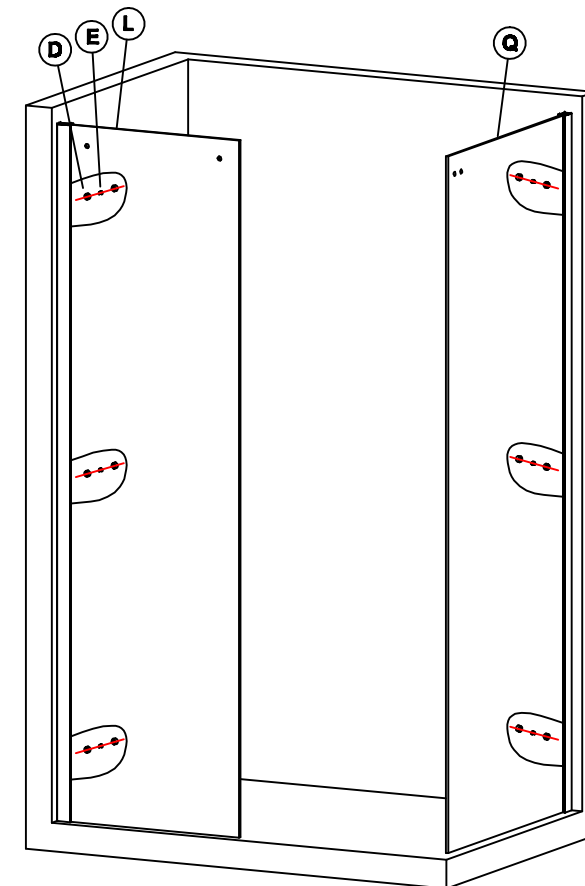
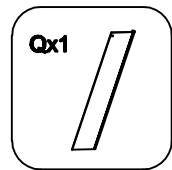
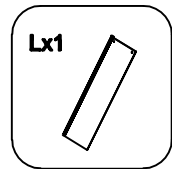
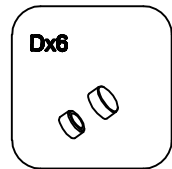

2

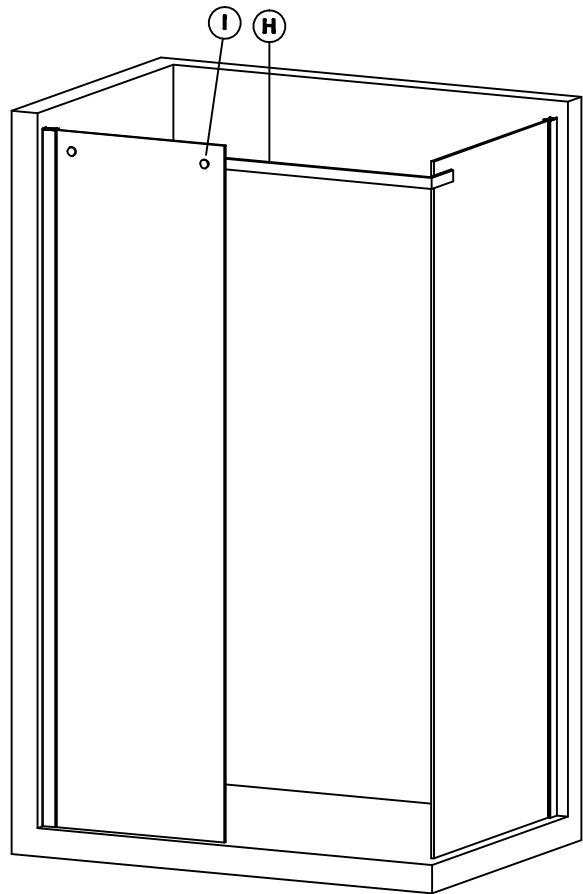
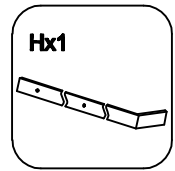
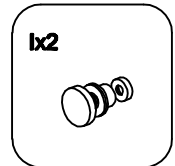

3

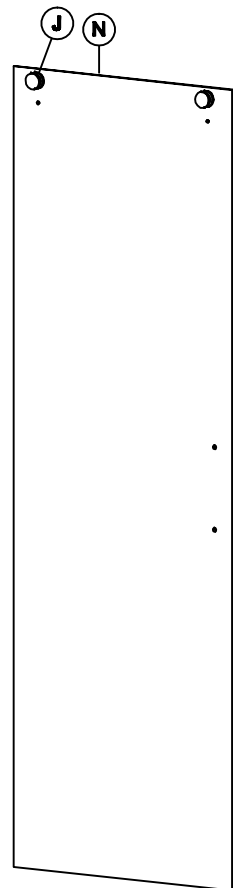
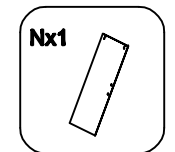
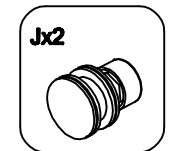

4

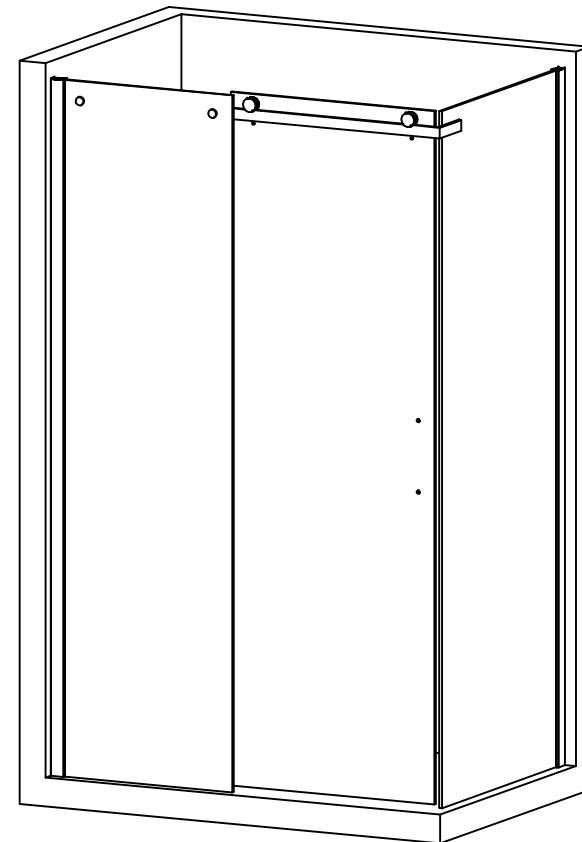
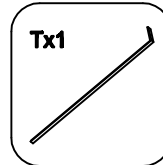
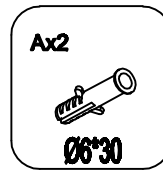
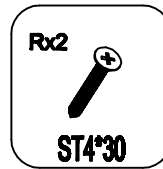
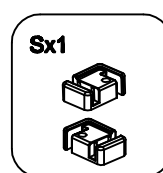

5

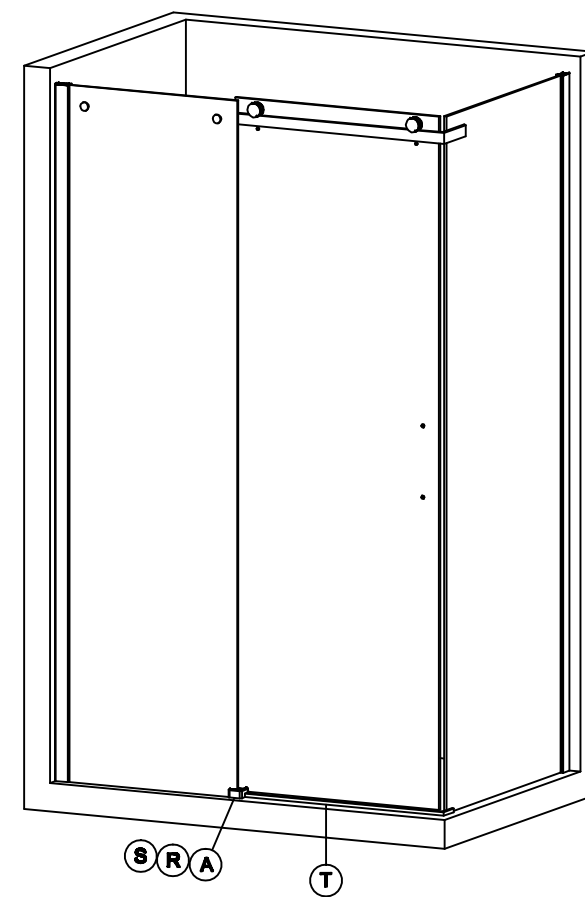

6