

















A  Ø6*30 X8	B  X1	C  ST4*30 X8	D  ST4*10 X6	E  X6	F  X1	G  X1	H  X1
I  X1	J  X1	K  X1	L  X1	M  X2	N  X1	O  X1	P  X2





Dx3

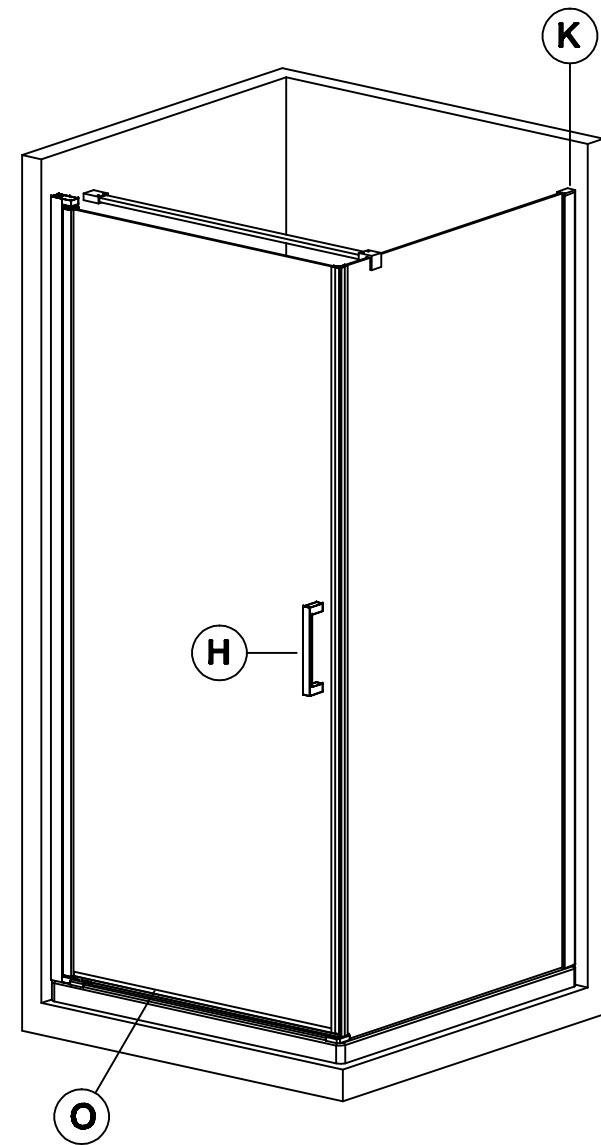
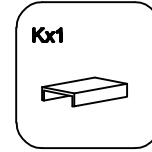
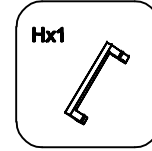
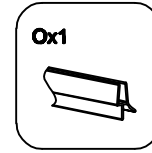
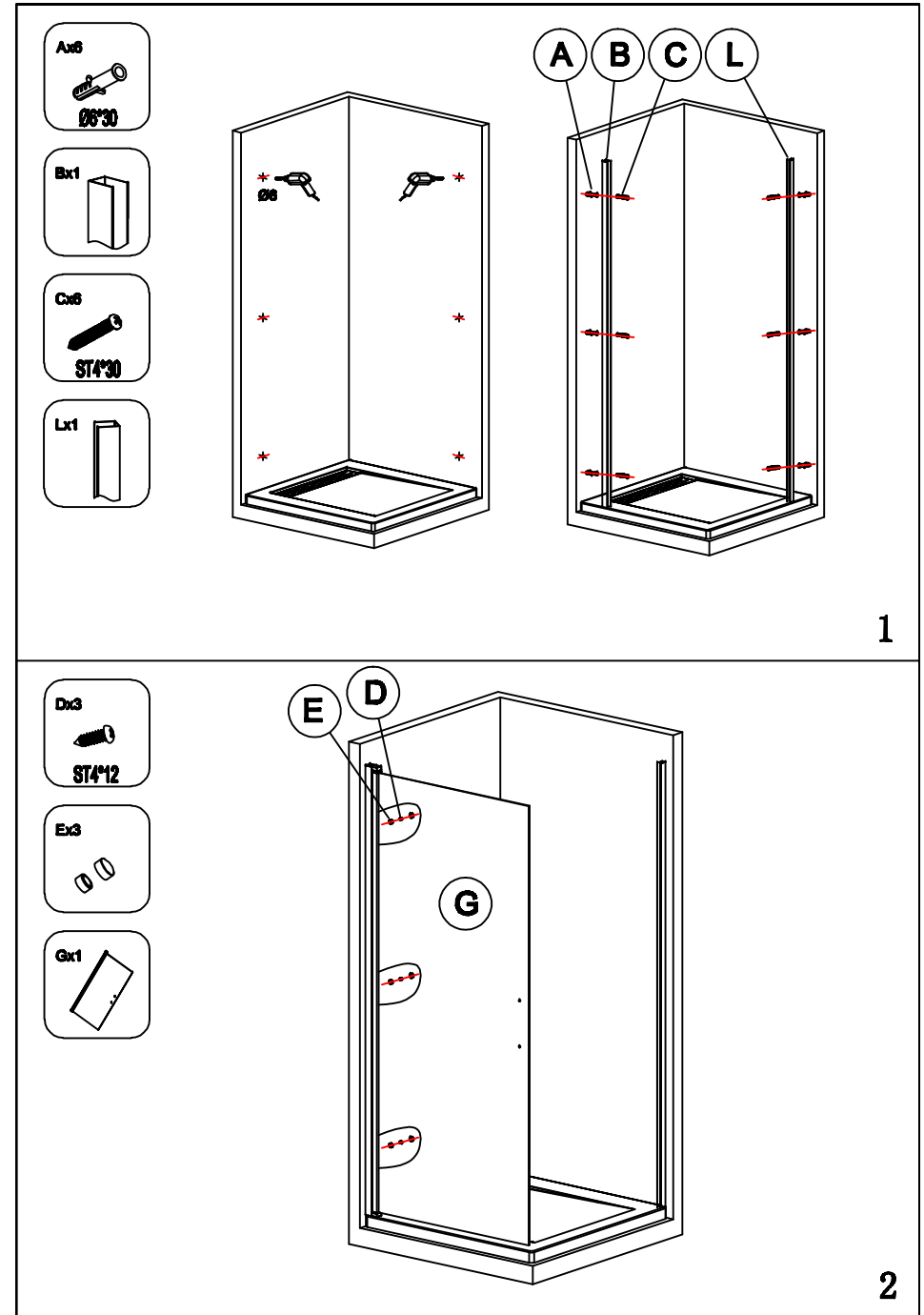
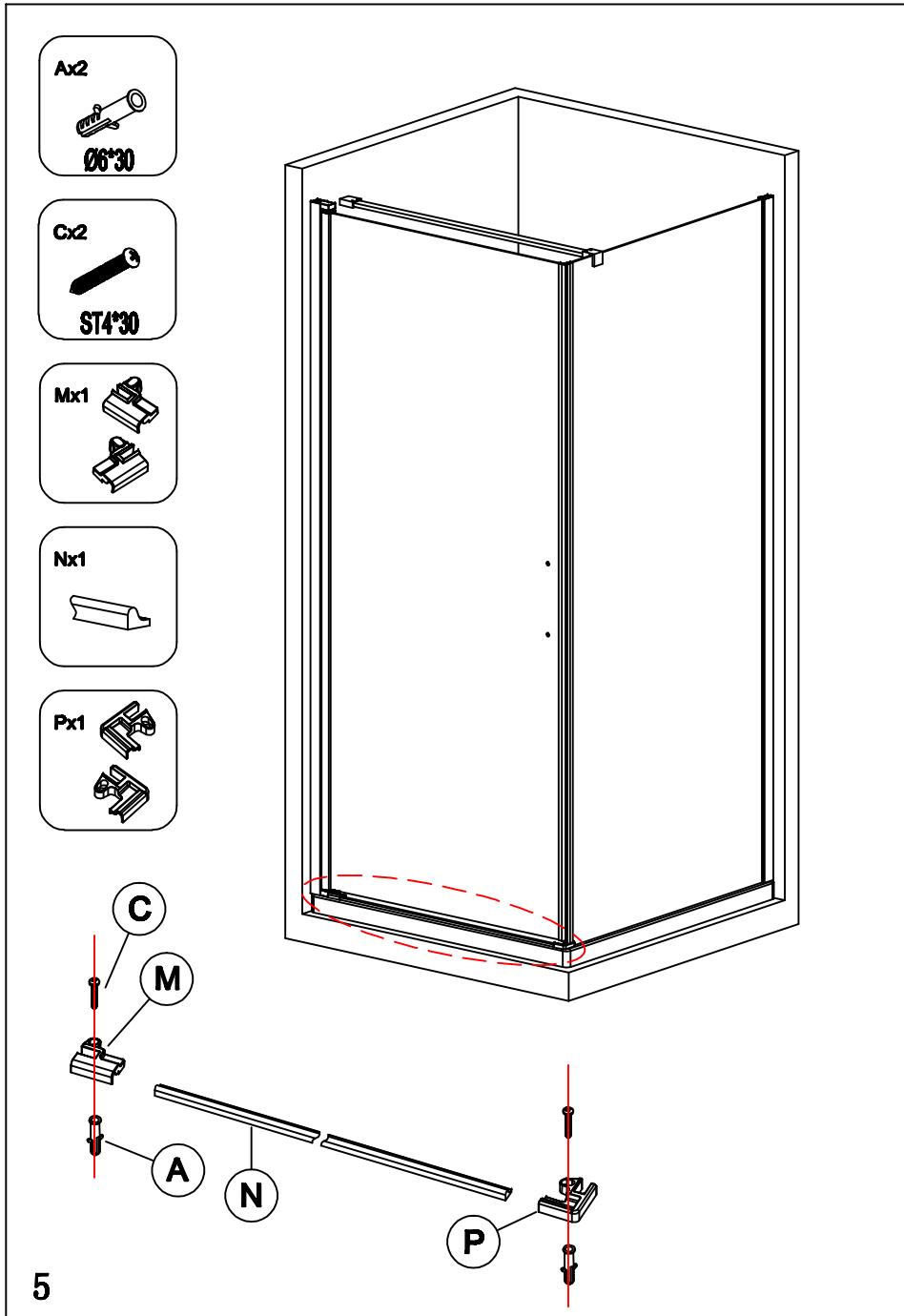

ST4*12

Ex3



Jx1

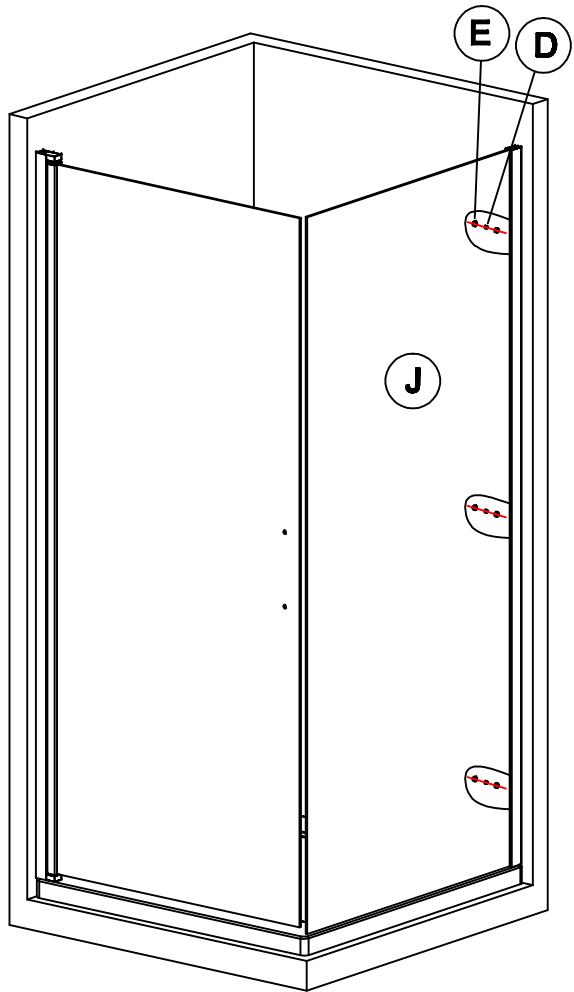

3

Fx1

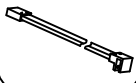

Ix1

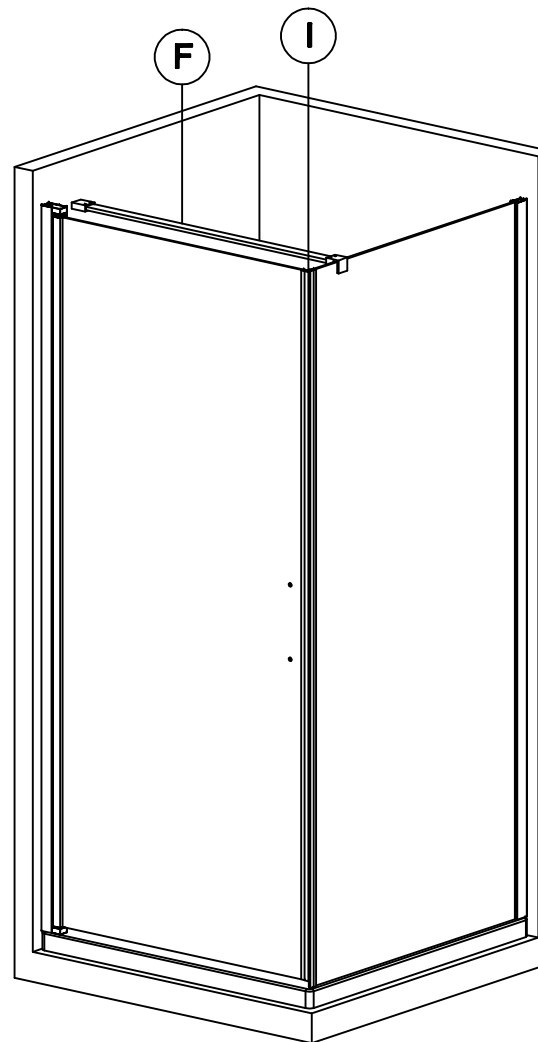
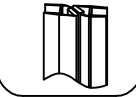

4